

# medem SEC-Le V4

## Installation Instructions

The SEC-Le is a gas pressure proving system with electrical isolation, gas detection and ventilation interlock.

The system will perform a down stream integrity check ensuring gas tightness before use, close the gas solenoid valve in the event of a high-level gas alarm, ventilation failure, low incoming gas pressure or if the emergency stop/fire alarm is activated.

It is designed for use primarily in laboratories.



- Gas Pressure proving.
- Electric Isolation
- Gas Detection .(up to 16 detectors with a power pack)
- Fan interlock. (optional)
- 5 year warranty - 10 years when commissioned

Before commencing installation please familiarise yourself to the equipment by reading the comprehensive installation instructions. If in doubt then please call 0161 233 0600. Out of hours please call 07894 684080 or 07843 355163.

**It is a statutory requirement that this safety system is installed and commissioned to the satisfaction of the manufacturer.**

A commissioning certificate must be issued to the end user along with instructions for the operation of the equipment.

As the Manufacturer Medem UK should commission this safety system whereupon a commissioning report will be forwarded to the installing agent who should provide a copy to the end user.

At the point of our commissioning an individual serial number will be attached to the system along with a 24 help line number. Photos and all relevant information for the installation will then be stored on the Medem site database to be accessed in the event of a call on the 24 hour help line. The warranty period for the panel and sender unit will then be extended to Ten years.

### Multi gas detection, air quality monitor and gas pressure proving system

The SEC-Le system comprises of a mains powered main control panel, and low voltage pressure sender unit and fitting kit. The pressure sender unit is mounted onto the gas valve (with the fitting kit) and transmits the gas pressure information back to the main panel in order to perform its integrity test.

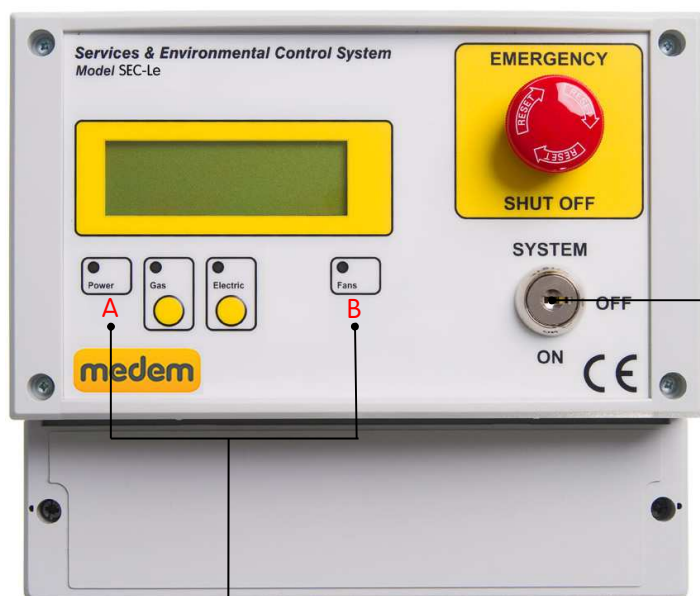

System On/Off enables gas detection and use of each soft touch service button



Pressure sender unit

A Blind button for displaying gas pressures on the LCD screen

B Blind button for displaying first 8 detectors (Gas & temperature) on the LCD screen.

### Control Panel

The front of the panel has the following controls and indications:

- Emergency stop button.
- System On/Off switch.
- Yellow soft touch On/off buttons for gas and electric.
- White Blind buttons A and B for engineer functions.

LED indications:

- Power On - green.....A: blind button for displaying gas pressures on the LCD screen
- Gas/Electric - red when active to warn of live service
- Fans running light – yellow...B: blind button for displaying connected devices (detectors & temperature) on the LCD screen

LCD display:

- For displaying system status during both installation and normal use, also for displaying diagnostics

### Pressure Sender Unit

Pressure sender unit transmits pressure information back to the main panel in order for it to perform its integrity test. It is not optional and must be connected, **the system will not work without it.**

It is mounted to the gas solenoid valve inlet and outlet test ports using 8mm OD copper pipe. Use the appropriate Medem fitting kit to fit the control valve size (see page 10,11).

The pressure sender is connected to the control panel with low voltage two core screened cable using the terminal marked A & B. **NOTE: This is low voltage and should be segregated from mains wiring.**

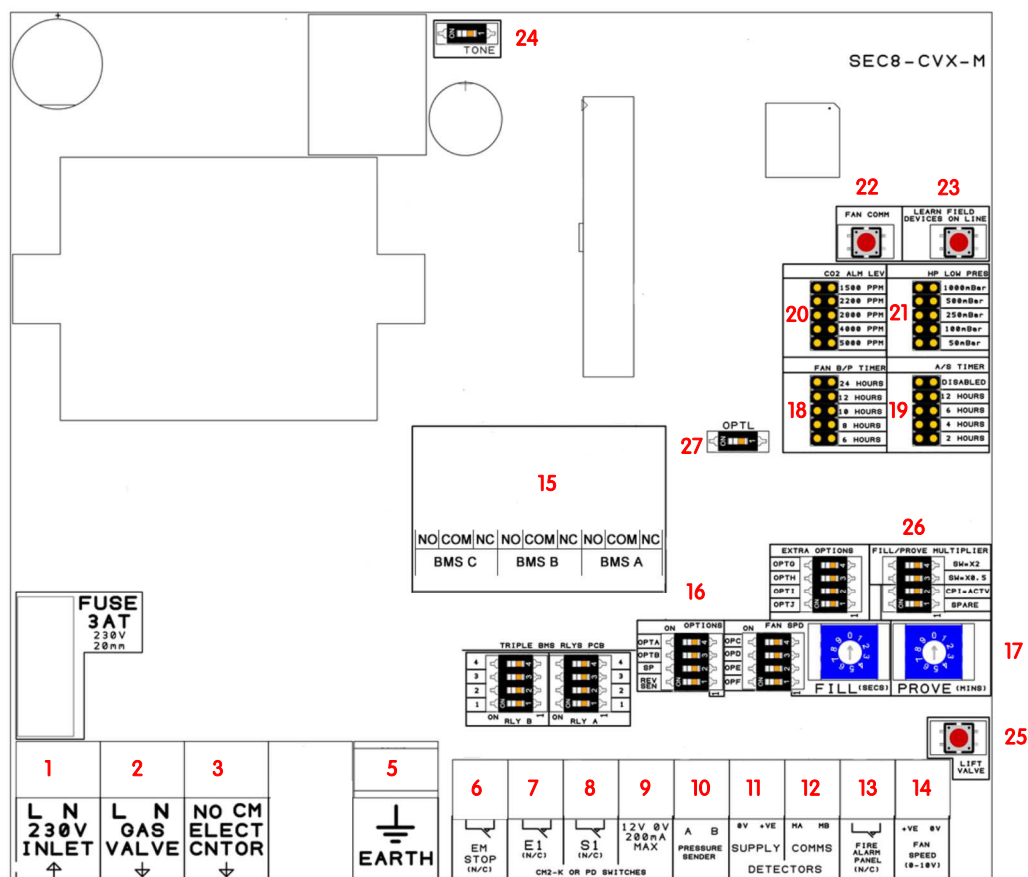

Power at 230  
volts from a  
3amp fused spur

### Connections to panel: marked on board

1. Live & Neutral 230 volts supply from 3amp switched fuse spur
2. 230 volts out to gas solenoid valve (required)
3. To contactor for isolating bench socket electricity supply (optional) see page 9
5. Earth connection terminals
6. Remote emergency stop and thermal links, SELV, connect in series multiple buttons (requires a N/C circuit)
7. Extract fan interlock for current monitor (CM2M-K) or PD switches.
8. Supply fan interlock for current monitor (CM2M-K) or PD switches.
9. 12 volt power for current monitor (CM2M-K)
10. Pressure sender unit SELV and comm's both through "A" & "B" terminals (2 wire) **(Required)**
11. Power connections for detectors, Methane, LPG, CO, CO2, Oxygen, Temperature
12. Comms connections for detectors, Methane, LPG, CO, CO2, Oxygen, Temperature
13. Fire alarm input signal (N/C contact required).
14. 0-10 volt output to fan speed controllers based on CO2 and temperature levels
15. Three relays, outputs for connection to a BMS see page 4 for full details.
16. OPTA=Over pressure check, will isolate gas supply if pressure exceeds 70 mbar
17. Fill & prove time for gas pressure proving, see page 5.
18. Timer adjustment for fan commissioning, allows timed period for gas installation commissioning.
19. Auto stop timer to isolate gas after set length of time. Factory set for model & use
20. CO2 alarm level adjustment depending on application. Factory set for model & use
21. High pressure low cut out adjustment (*when high pressure sender unit is used 1 bar*)
22. Fan comm button, enables commissioning of the gas supply without fans running.
23. Learn field device button, press once only when all detectors are connected and powered (verify with Blind button B).
24. Selector switch to disable audible alarm sounder.
25. Lift valve button, opens the gas valve only whilst the button is continuously pressed, for commissioning purposes.
26. Fill/Prove Multiplier SW=X2 multiplies the prove time by 2, CPI=ACTV Can monitor position of a CPI switch on a gas valve when used with a CPI pressure sender unit.
27. OPTL Enable/Disable the front panel "FANS" LED (switch on to disable)

### Blind buttons - engineer features

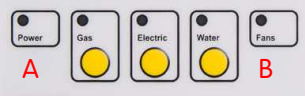

Press button A - To display the gas pressures and view the set pressure proving set times.

Press button B - To display the gas installed gas detectors 1-8 press A & B together to view 9-16.

#### Fire Test Mode (Press button B three times)

When connected to a fire alarm panel using the fire alarm terminal (no.13) the system will isolate the gas during an fire alarm.

If for the purposes of a fire test you wish to temporarily disable this interlock the SEC system can be put into a "fire test mode" by pressing blind button B three times in quick succession.

This is a timed feature and will auto clear after 45mins. Press again three times to manually clear and return to normal running.

### 15. BMS Relay PCB

Two relays, for connection to a BMS or sounder/Beacon (One status selectable from each relay)

Max switching 48 volts 1 amp

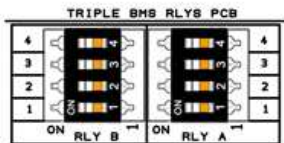
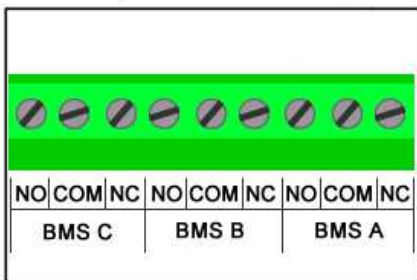

	ALT	EST	GON	HAL
	1	2	3	4
Low Pressure (Any State) - LP	OFF	OFF	OFF	OFF
High Pressure (Any State) - HP	ON	OFF	OFF	OFF
Test Fail	OFF	ON	OFF	OFF
Fan Fault - FF	ON	ON	OFF	OFF
EM Stop - ES	OFF	OFF	ON	OFF
Fire Panel Active -FA	ON	OFF	ON	OFF
High Alarm (Any State) - HA	OFF	ON	ON	OFF
Low Alarm (Any State) - LA	ON	ON	ON	OFF
Gas On State	OFF	OFF	OFF	ON
Detector Fault	ON	OFF	OFF	ON
Generic Fault (LP,HP,FF,ES,FA,HA)	OFF	ON	OFF	ON
Key Switch State	ON	ON	OFF	ON

### 17. Fill and Prove

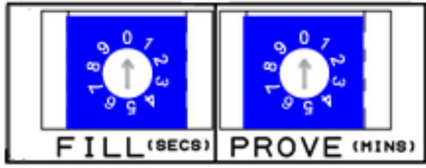

**Gas Fill Time.**

The Fill Time should be set such that there is sufficient time to fill an empty pipe work system to full / normal pressure while ensuring a minimum escape of gas where a leak exists.  
(Factory default setting is 5 seconds).

**Gas Prove Time.** This should be set such that the smallest leak can be detected. This time can be set up to a maximum of 9 minutes. Increasing this time effectively makes the system more sensitive to gas leaks.  
(Factory default setting is 1 minute).

FILL switch @ 1,2,3,4,5,6,7,8,9,0 = 1s, 2s, 3s, 4s, 5s, 6s, 7s, 8s, 9s, 10s,  
PROVE switch @ 1,2,3,4,5,6,7,8,9,0 = 1m, 2m, 3m, 4m, 5m, 6m, 7m, 8m, 9m, 30s,

The prove time can be extended using FILL/PROVE MULTIPLIER, see No 26.

### 18, 19, 20, 21 Option Headers

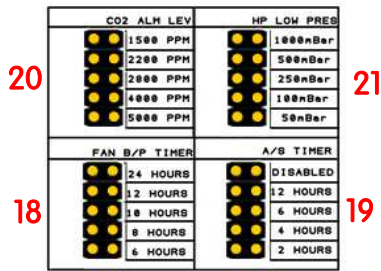

**18.** Timer adjustment for fan commissioning, allows timed period for gas installation commissioning.

**19.** Auto stop timer to isolate gas after set length of time. Factory set for model & use

**20.** CO2 alarm level adjustment depending on application. Factory set for model & use

**21.** High pressure sender unit: Low pressure cut out adjustment (for systems over 1 bar)

### 22, 23 Fan Comm & Learn Detectors

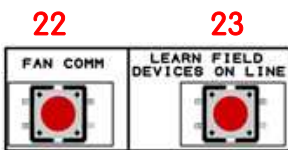

**Fan comm.**

To enable the commissioning of the gas portion of the system before the ventilation interlock is completed you may temporarily disable the interlocking by pressing button **22**. This will bypass the ventilation interlock allowing the gas to be tested, the system must not be left in this state and as such is only for a maximum 24hour period before auto exiting. **While in commissioning mode the display will show the message "Not to current standards"**. Pressing the button again at anytime will cancel commissioning mode.

**Learn Field devices.**

Any gas detectors connected to the system will require "learning". First ensure all detectors are set to a unique ID address using the selector switch on the detectors themselves. Having addressed each detector press the learn field devices button (**23**), the system will scan and store any connected detectors. To verify that all detectors have been successfully learnt press the "blind button B" on the front panel to view address details.

### 26. Fill/Prove multiplier

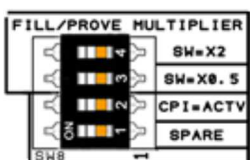

**SW = X2** This doubles the fill & prove time.

**SW = X0.5** This halves the fill and prove time test, please note the minimum prove time is 30 seconds which cant be reduced any lower.

### Gas Detection

#### Gas Detectors

**IMPORTANT** - Gas Detectors should not be installed until all building, construction or painting work etc.. Is completed, as these works can effect the sensitivity and longevity of the detectors.



Ensure that the protective cover labels (**RED**) are removed only after the completion of all building work and the system has been commissioned by the Medem engineer.

The labels are required to be removed for the detectors to operate, but removal before the completion of works risks contaminating the sensor element.

The system is capable of operating a mix of up to 16 detectors (additional power pack may be required) of different types.

The detector types are:

- Carbon Dioxide.
- Carbon Monoxide.
- Combustible gases (Methane, Propane).
- Oxygen depletion and temperature.

Detector location will vary dependant on the individual characteristics of the target gas that is being monitored for. See the gas detectors own instructions for more guidance.

### Connection and addressing

When addressing gas detectors CO & CO2 detectors must be numbered before natural gas detectors.

#### Address Selector

Each detector must be set to its own address and then "learnt" using button (23, see page 5)

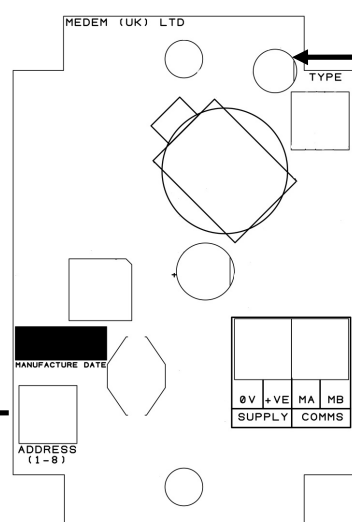

Status LED

+VE supply & Comm's  
From either the main panel or an extender.

Detectors are wired in parallel and can be connected to one another daisy chain

All current wiring regulations must be followed with reference to running low and mains voltage cables together.

The maximum cable length between a detector and the control panel should not exceed 100 meters, if the distance between the main panel and the detectors is greater than 20metres a 1mm screened cable must be used on the +VE, 0v terminals

Gas detectors, require a **four core** screened Belden type security cable or 600v rated BMS cable (max cable length of 100meters.)

Remote emergency stops and thermal links require a two core screened cable.

Warranty will be void if Fire Protection Cable or cable over 1mm dia. is used on the SELV side.

## Detector Indications

Each detector has its own Bi-Colour LED which is used to indicate the status of that detector.

Not Lit:	No power/comm's. These are four wire units and all connections are required (0v, +VE, MA, MB), check the polarity of both the power and the comm's (MA/MB) terminals are correct.
Flashing Green:	Detector is warming up, the detectors will flash green on power up for 90 seconds while the sensor elements stabilize. The system will ignore any detectors while flashing.
Solid Green:	Detector is powered and active. <b>Note:</b> The detectors will still require correctly addressing (using the address selector pot) and learning by the system using button 23, (see page 5).
Flashing Red:	Low level alarm. All detectors have both a low and high level alarm, low level alarms serve as a warning that an unsafe condition maybe building and gives chance to intervene before loss of gas service.
Solid Red	High level alarm. An unsafe level of the target gas have been reached and the system will isolate the gas supply. The cause of the alarm will require identifying and resolving before the gas supply can be re-established.

After installation a simple bump test can be performed by using an appropriate level test gas in order to check operation. Full testing and calibration checking takes place during a Medem commissioning.

## Detector Location

Detector location will vary dependant on the individual characteristics of the target gas that is being monitored for. The descriptions below describe the position for each detector after considering these characteristics.

For proper function care must be taken not to site a detector in a "dead space" or in the flow of any ventilation.

### **Natural Gas/Methane**

Natural gas detectors should be mounted at high level on a wall approximately 150mm from the ceiling height and avoiding corners and potential dead air areas.

Natural gas detectors should not be mounted below the height of the top of a doorway for example. This is because as the gas is slightly lighter than air it will rise filling the room from the ceiling down and will spill through the top of a door opening into the next room. If the detectors are mounted below this height then it will take longer the gas to reach the detector.

### **LPG /Propane**

LPG gas is heavier than air so detectors need to be mounted at low level 100mm from the floor, consideration should be given to any potential mopping or wet floor height.

### **Carbon Monoxide**

Carbon Monoxide is similarly weighted to air so detectors should be mounted between 1 to 2 meters from the floor.

### **Carbon Dioxide**

Carbon Dioxide detectors should be installed so they monitor the general level of CO2 within the area. They should be mounted above standing head height and between 1m and 3m from the potential source. Care should be taken so they are not located close to the edge of a canopy or in direct flow of the supply or extract ventilation.

*For additional information or guidance on site specific requirements please don't hesitate to contact us.*

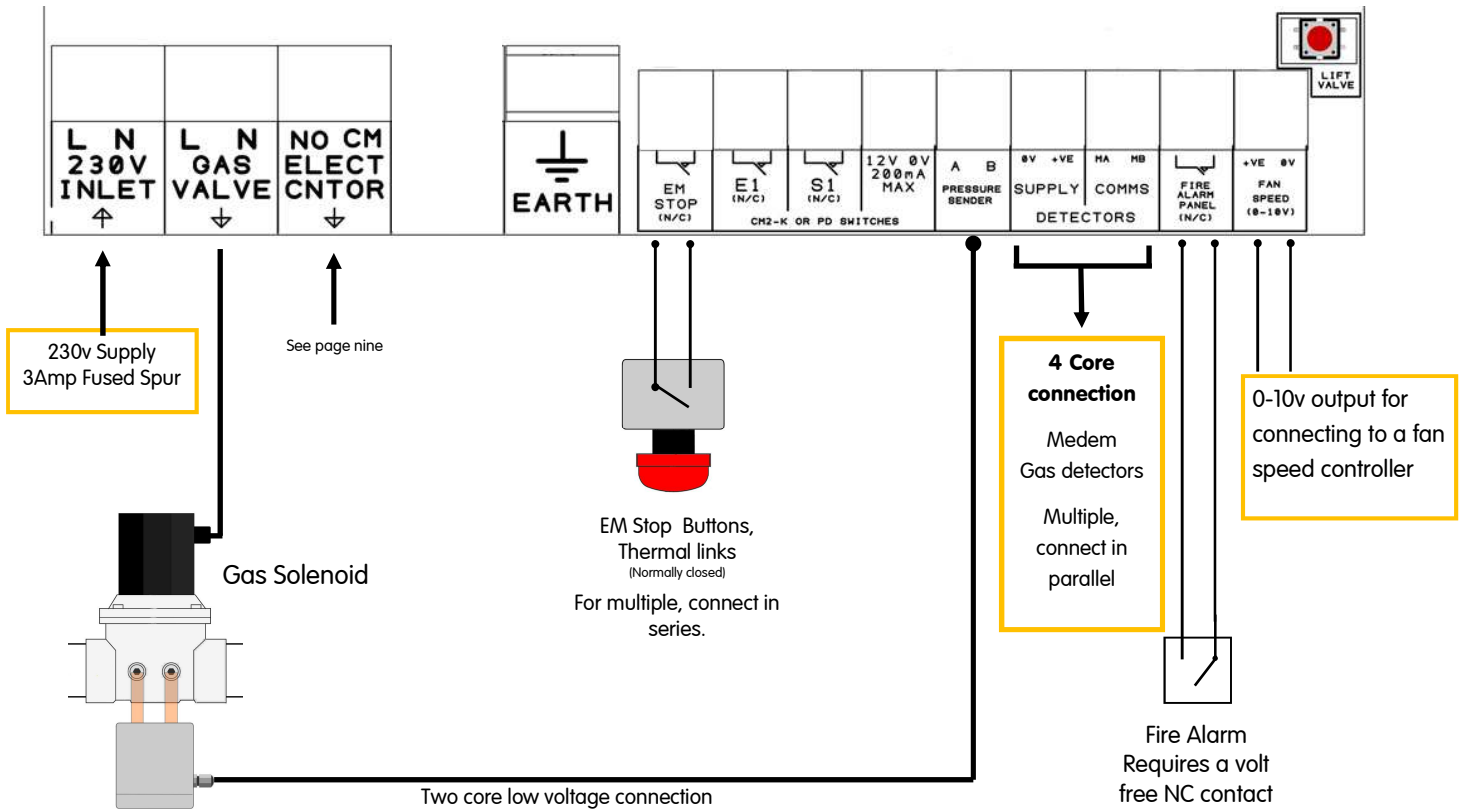

Pressure Sender unit mounts on to the body of the gas valve  
*(Required)*

Earth Connections not shown

### Fan Interlock Connections

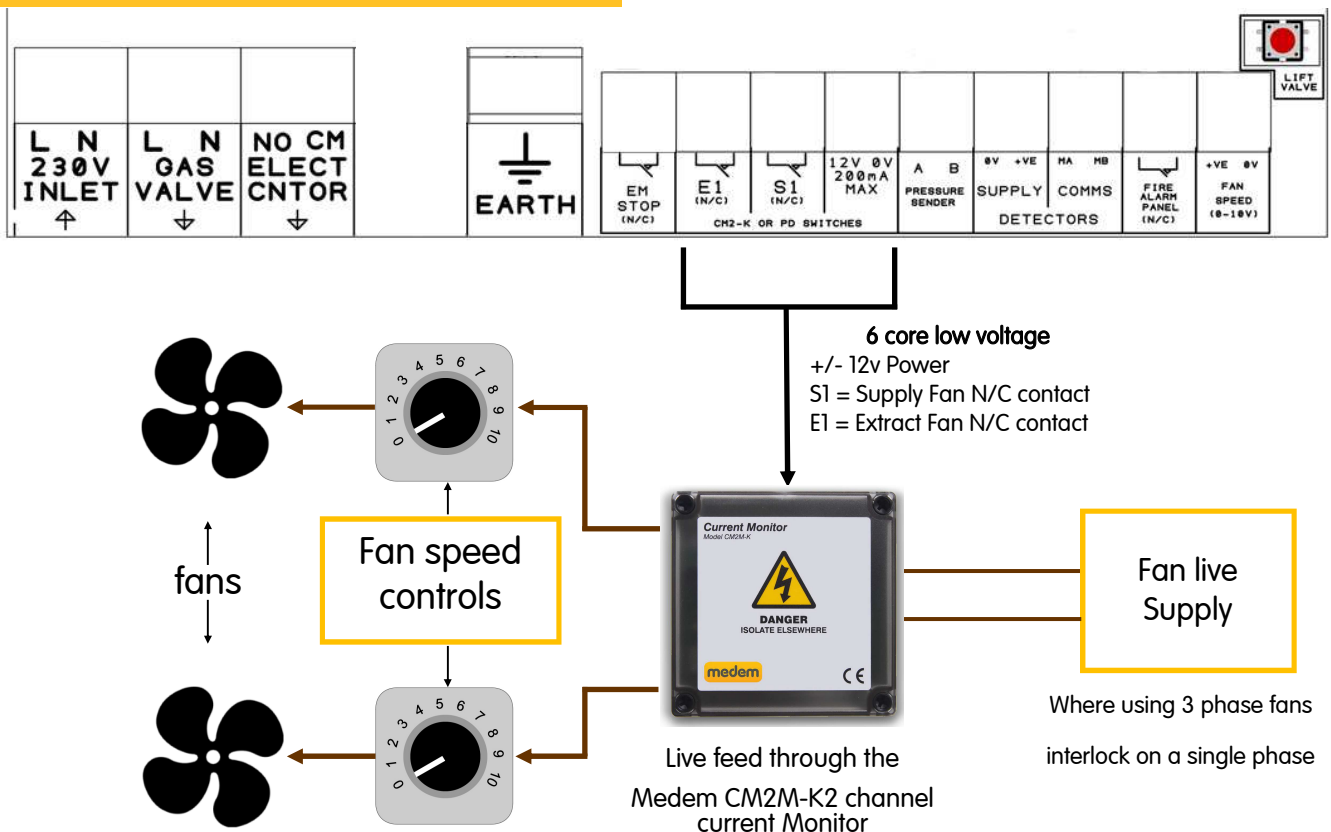



### Method One (Preferred)

#### Method 1 (Preferred)

Using this wiring method, when isolating the supply there are no other voltages present within the panel.

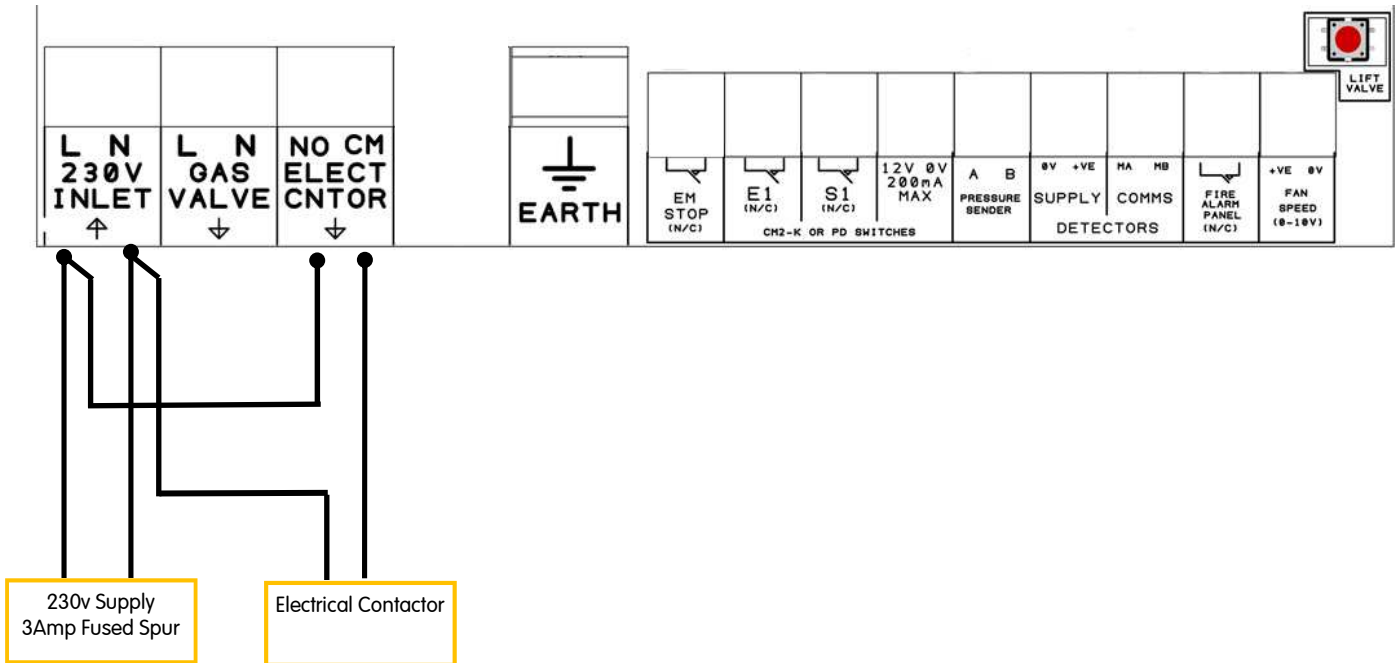

### Method Two

**IMPORTANT!** If wired this way, a warning notice must be attached to the panel to indicate that there are two separate mains feeds.

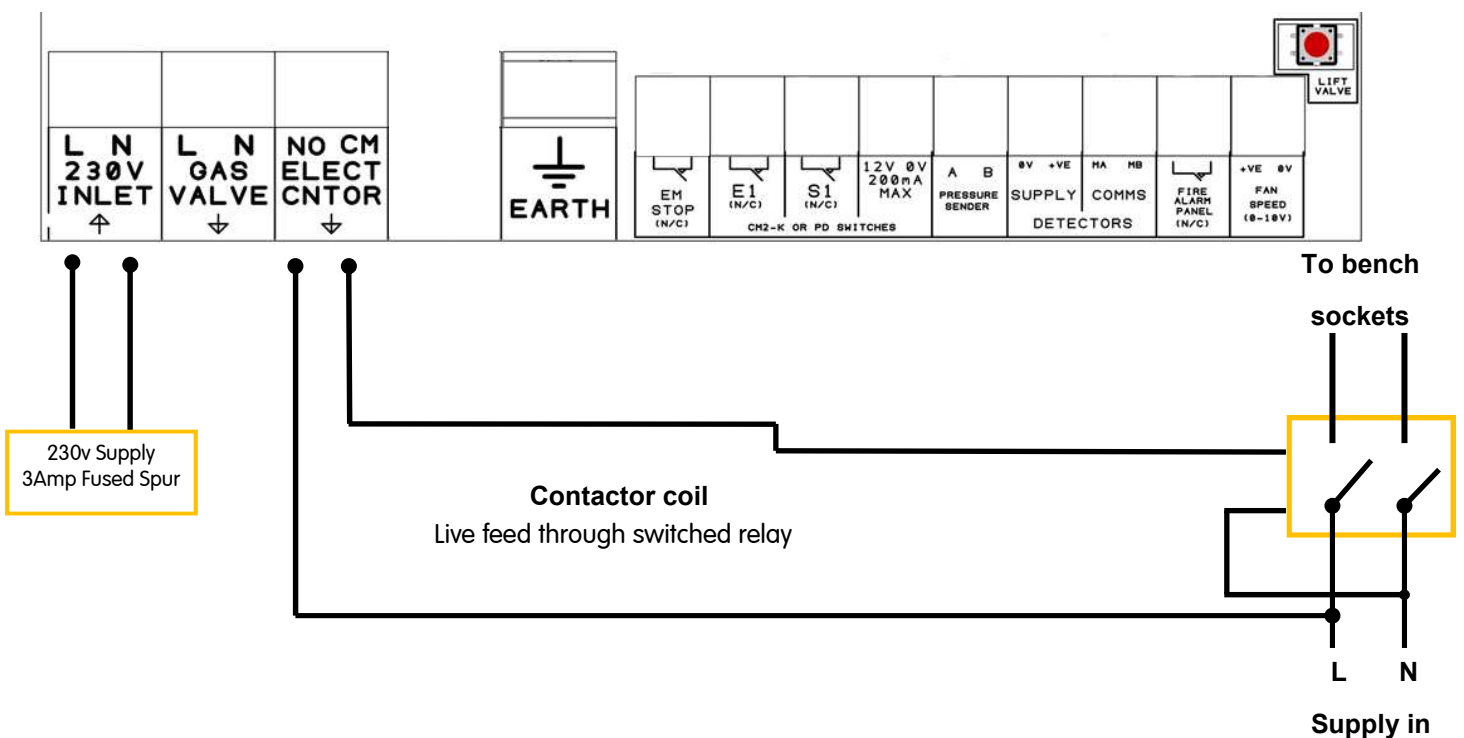

Direction of flow

Ensure that the valve is correctly installed with regard to the direction of the flow of gas and that the Sender Unit is fitted the correct way round. (Note: there is no flow "through" the pressure sender unit, it is purely reading the pressures either side of the valve).

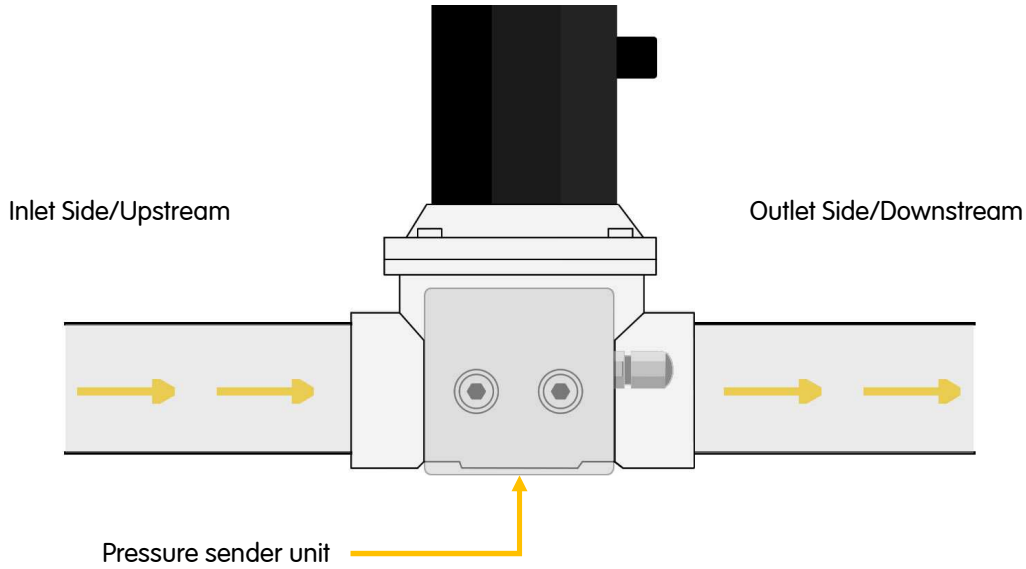

Gas Solenoid and Sender Unit Mounting

Never mount the valve such that the Solenoid or Sender Unit are below the horizontal.

Correct

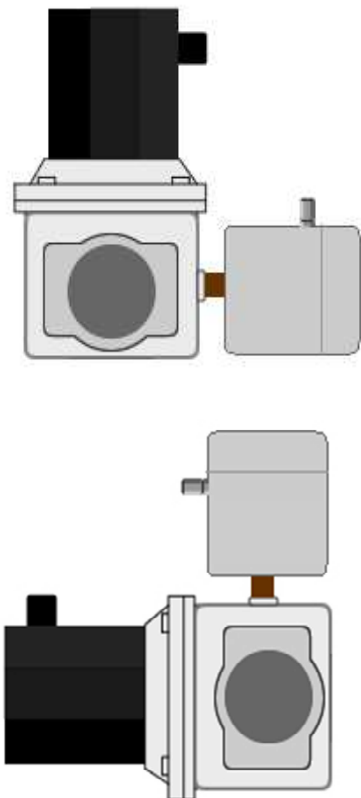

Incorrect

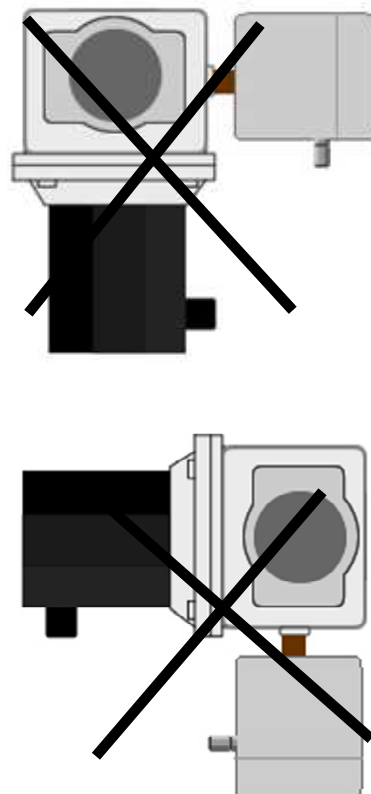

### Mounting details - Fitting kit

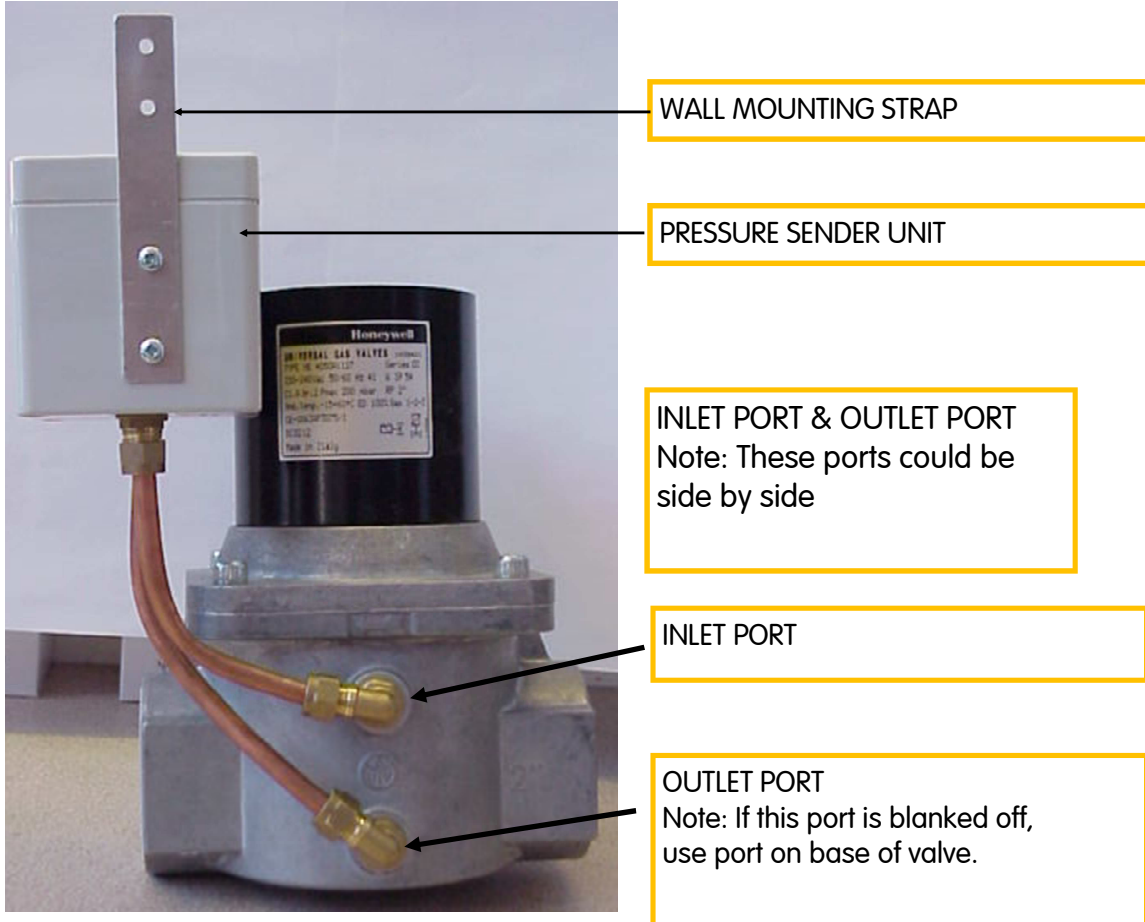

#### NOTES:

Solenoid coil of the valve should never be mounted below the horizontal.

Pressure sender unit should never be mounted upside down (to protect from water ingress)

### Fitting kit - Contents



Approx 400mm length

### Single Stop Buttons

Remote stop buttons can be connected to the panel terminal marked as "EM STOP" (number 6).

The remote buttons must be wired as shown in order to provide a "closed contact" for the control panel.

**If thermal links are to be installed these should be wired in series with the EM stop buttons**

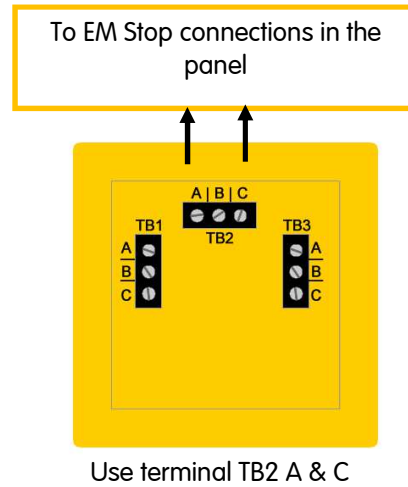

### Multiple Stop Buttons

Multiple stop buttons are wired in series.

If thermal links are to be installed these too should be wired in series with the EM stop buttons

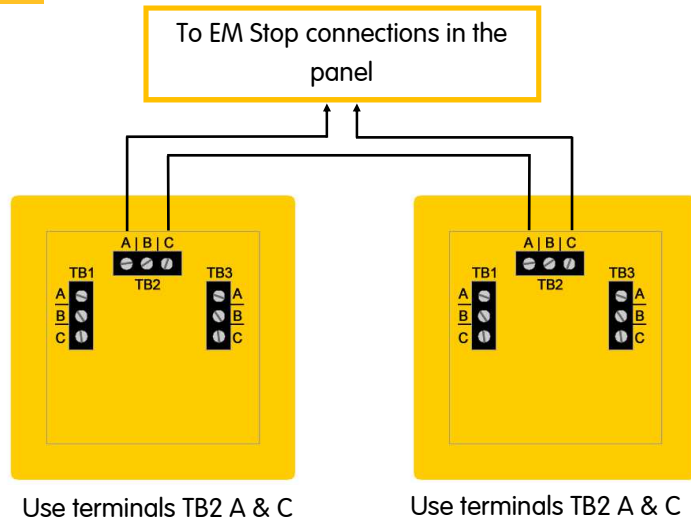

### Resetting (indicator bar)

The stop buttons supplied by Medem are of a "Push Glass, key resettable" style, when activated a yellow indicator bar will show and the unit will require resetting using the key provided.

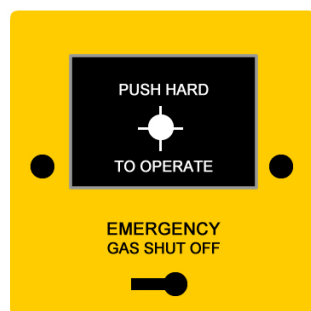

Normal

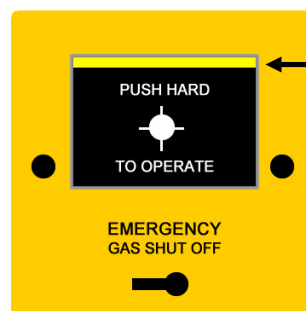

EM-Stop Activated

Medem (UK) Limited  
Project House  
19 Dallimore Road  
Manchester  
M23 9NX

Tel: (0) 161 233 0600  
Fax: (0) 161 233 0601

Web: [www.medem.co.uk](http://www.medem.co.uk)  
E-mail: [sales@medem.co.uk](mailto:sales@medem.co.uk)

## Medem UK Warranty Terms & Conditions

1. The warranty is a parts warranty and Medem UK Ltd will not cover or accept any labour or other expenses that may be incurred in the process of changing faulty product.
2. All panels and sender units are covered by a five year warranty.
3. Gas detector units and other remote detectors carry a two year warranty. Installation of the detectors should not be undertaken until all building and construction work is completed.
4. Gas solenoid valves carry the original manufacturers warranty, though as the supplier Medem UK will exchange faulty valves for return to the manufacturer.
5. Where a Medem UK engineer (or another company appointed by Medem UK) commission and installed system then that system will carry a ten year warranty. This applies to the main panel and the sender unit. At the time of commissioning a security label with a serial number will be attached to the main panel box. photographs and a comprehensive record of the installation will be held by Medem UK.
6. Where a warranty claim is made then, where appropriate, a written order to attend site must be provided to Medem UK A cost for labour and travel to site will be prepared as a quote. The cost must be included in the order.
7. Where it is found that the installation and/or the quality of workmanship has contributed to or wholly caused the failure of the product then we reserve the right to charge the whole or a proportion of the cost of the faulty item.

It is essential that the installation is carried out in the order given below to ensure the correct operation of the system.

First read the system description sheet before following the instructions below

1. Connect the gas valve to the marked terminals "gas valve".
2. Connect current monitors where required (7 & 8 on diagram)
3. Connect the pressure sender unit to the marked terminals (10)
4. Connect any additional EM stop buttons or thermal links in series to the terminals marked "EM stop" (6)
5. Each detector/device has a rotary address switch, each switch should be set to a different number or letter starting with "0". Then connect the gas detectors to terminals marked "detectors" on the panel. Detectors are wired in parallel. "Daisy chain" (11 & 12 )
6. Connect fire alarm, ensure potential free n/c (13)
7. Connect 0-10 volt to speed controllers 0-10 volt inputs where required (14)
8. Ensure any BMS connections are made to the relays (15)
9. Connect the 3 amp fused spur 240 volt supply to marked terminals.
10. At this point check that the sender unit has been fitted to the control valve and that gas is available
11. Once power is connected to the panel the detectors will flash the green LEDs for 90 seconds after which the LEDs will be on continuously.
12. Press the "learn field button" (23) this is on the main circuit board on the right hand side, just over half way up the board pressing this once allows the panel to learn how many and which type of detectors are fitted.
13. Press and keep pressed the "display detectors" button whilst checking on the LCD display that all the detectors have been recognised by the panel. A recognised detector will appear as "CO" Carbon Monoxide, "CM" combustible, "CH" Carbon Dioxide, "OX" Oxygen depletion and "TP" Temperature. Count the number of "seen" detectors on screen and ensure total is the same as the number of detectors installed. "NM" in the third column means that number is not monitored. If more than 8 detectors are fitted then press both the "display detectors" and the "pressure" buttons together to view the next 8 detectors. **Note** that a detector set at 0 appears as 1 on the LCD and a detector set as 1 appears as 2 on the LCD etc.
14. At this point turn the on/off switch to the on position press the "gas" button, the panel will test to ensure gas tightness and provided there are no leaks the panel will allow gas through and the gas on LED will light. Should the gas test fail then press the pressure button to see the pressure in mbars on both sides of the valve. Thus you can see the pressure drop downstream provided the valve is closed
15. Check that the panel can see the smallest allowable pressure drop if it does not then increase the proving time by adjusting the blue rotary dials (prove time) on the circuit board and or by switching on SW=X2 (16)
16. Check the operation of the electric contactor by pressing the 'Electric' button on the panel lid to switch on and off.

#### Notes.

It is recommended that all systems are commissioned after installation by Medem UK. This will extend the warranty period from 5 years to 10 years and ensure the system is working as designed.  
Please see warranty conditions that came with the main panel

**Please do not hesitate to call for advice on the following numbers:  
0161 233 0600 office hours  
Or out of hours call:**

In the event of any alert the system will always give a reason on screen as to the cause.

Common messages you may receive are shown below with further explanation.

If you require any help or if anything is unclear then please contact technical support on 0161 233 0600

#### **Test fail check all appliances:**

The system has found an escape of gas, the most common cause is an open appliance. Check all appliances are off and restart the pressure test. If the system still reports test fail then a leak will be on the pipe work. Using "Blind button A" (see page 2) you can view the gas pressures at the valve, the outlet pressure must remain at least 90% of the value of the inlet pressure or a leak will be declared.

#### **Error from valve sender unit**

System is not receiving data from the sender unit. The pressure sender is a required part of the system and cannot be "linked out". Verify the sender is correctly wired and that you have a green flashing LED on the sender unit.

#### **Detector fault XX**

The system believes it has lost connection to a detector on address XX, verify detector addresses and press the "learn button" (23). Verify all connected detectors are being registered by pressing "blind button B" (see page 2). If you have no detectors connected to the system pressing the learn button will clear the error message.

#### **Supply and/or Extract fans not running.**

The system can monitor the fan status via a current monitor or air pressure switches. These provide a closed contact to terminals S1 and E1, it is a requirement when using fan interlocking that the fans be running (and therefore the S1 and E1 receiving a closed contact) before the system can begin a gas pressure test. If at any point the fans stop running (opening the S1 or E1 contact) the system will isolate the gas and report fans not running. Check that the fans are not only switched on, but actually running and moving air.

#### **Low incoming gas pressure.**

The system requires a minimum of 13 mBar of pressure at the inlet side of the gas valve, this is to ensure a correct strength flame. If at any time the incoming pressure drops below 13mBar for more than 10 seconds the system will isolate the gas and report "low incoming gas pressure"

Note: if this occurs during installation check the sender unit direction of flow, if the sender is installed backwards the system will believe the "outlet" to be the "inlet" and therefore see an open end as being low incoming gas pressure.

#### **Emergency stop button pressed.**

The system has an panel mounted emergency stop and connection inside for remote buttons. First check the panel button (once pressed some require resetting by twisting and releasing). Clear the message by turning the main system switch off and then back on, if the message remains check any remote buttons and their connections. The terminal for the remote buttons requires a volt free normally closed contact, ensure all remote stop buttons, thermal links any another connected systems (BMS/Fire panels) are reset and the contacts are closed.